

Velkomin í íslensku umferðarmerjaskrána

Þessi skrá inniheldur öll upplýsingamerki (D- merki) samkvæmt íslenskri umferðarmerkjareglugerð í mælikvarða 1:4. Hver merki hefur sitt „lag“. Auk merkjanna eru málsetningar í skránni. Athugið að táknin eru öll „læst“. Hægt er at taka af þeim afrit en til að vinna með þau þarf að „opna“ þau.

Gangi ykkur vel!





D01.11 Bifreiðastæði



D01.12 Bílastæðahús



D01.21 Bifreiðastæði
fyrir fatlaða.



D01.22 Bifreiðastæði fyrir
fatlaða með skráningar-
númeri bifreiða.



D01.31 Bifreiðastæði
fyrir hóp bifreiðir



D01.32 Sérstök bifreiðastæði



D01.33 Bifreiðastæði fyrir fólksbifreiðar

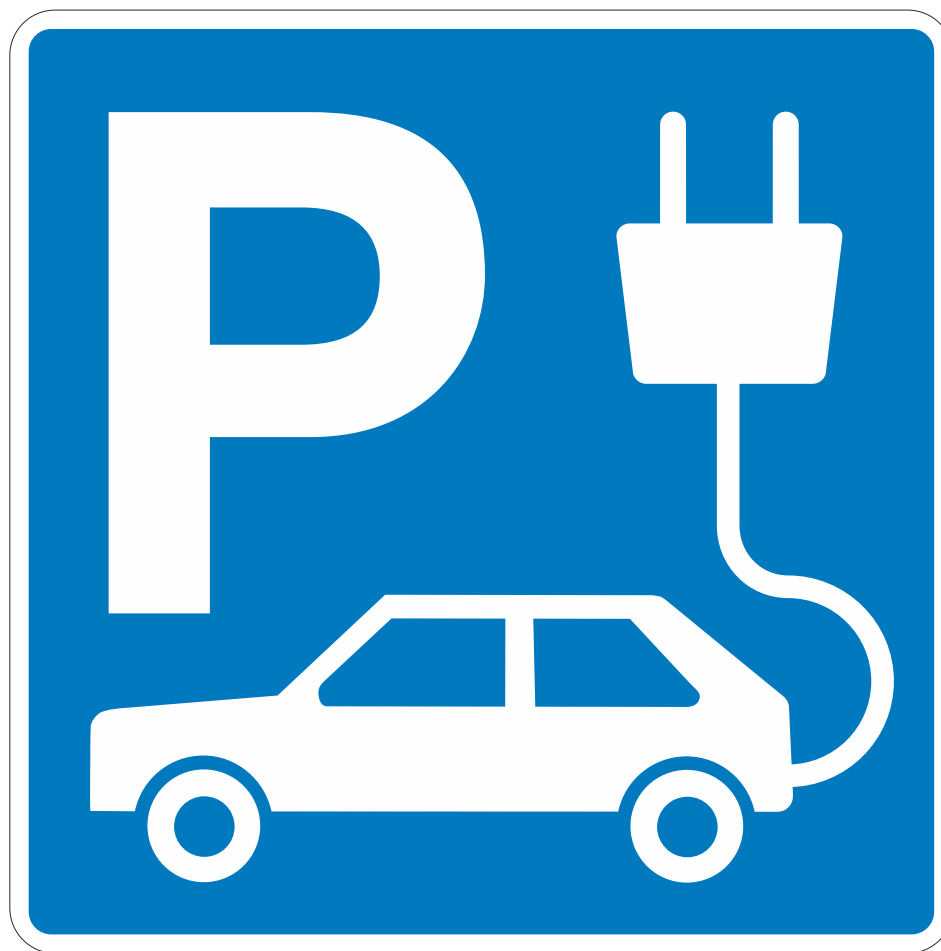

D01.34 Bifreiðastæði með rafhleðslu



D01.35 Bifreiðastæði
fyrir húsbíla



D01.37 Bifreiðastæði fyrir sjúkrabifreiðar



D01.41 Stæði fyrir reiðhjól



D01.42 Stæði fyrir mótorhjól

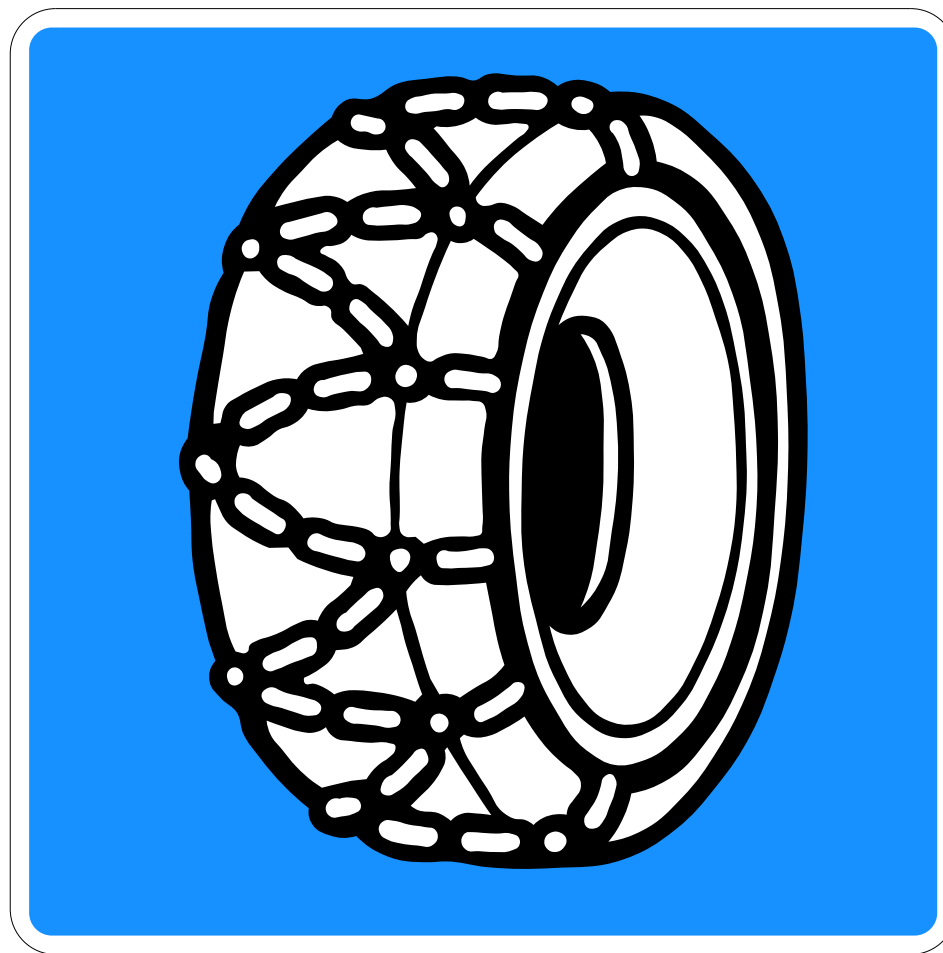

D01.61 Keðjunarstaður Merki þetta er notað til að sýna hvar eru útskot við veg sem sérstaklega eru ætluð fyrir öikumenn sem þurfa að setja á keðjur eða taka af, gjarnan við heiðarsporða.



D02.11 Gangbraut

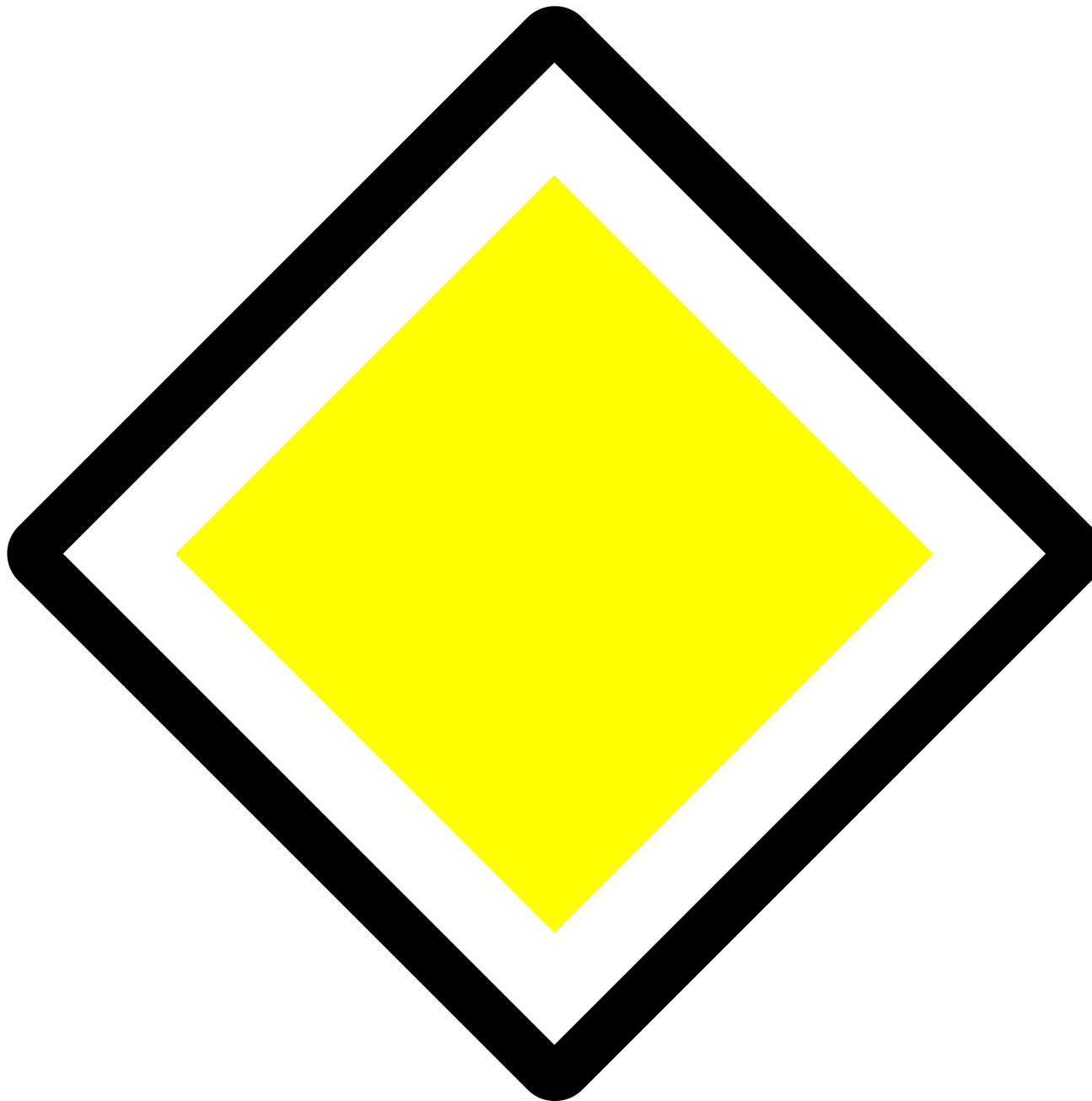

D03.11 Aðalbraut

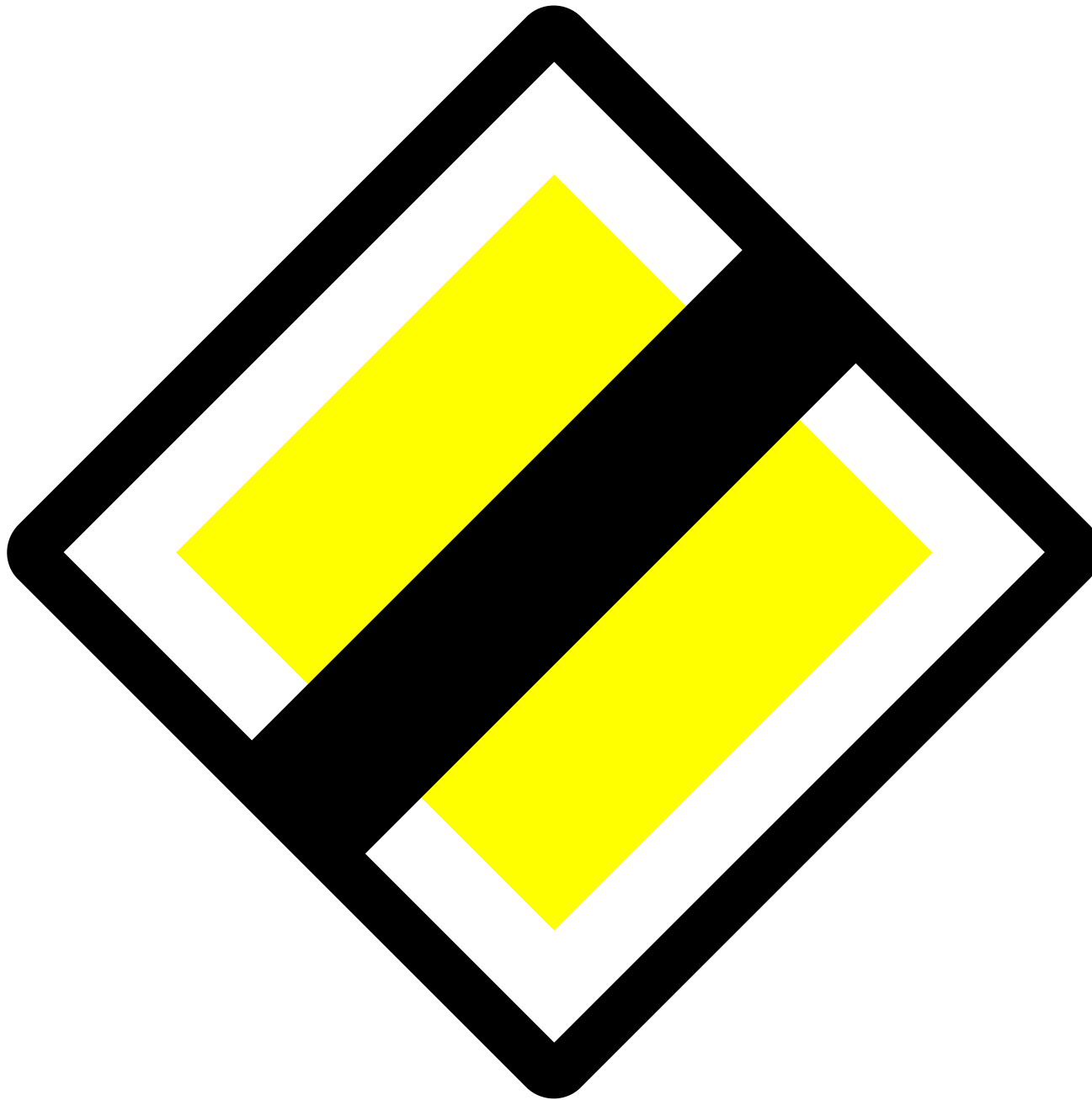

D03.21 Aðalbraut endar

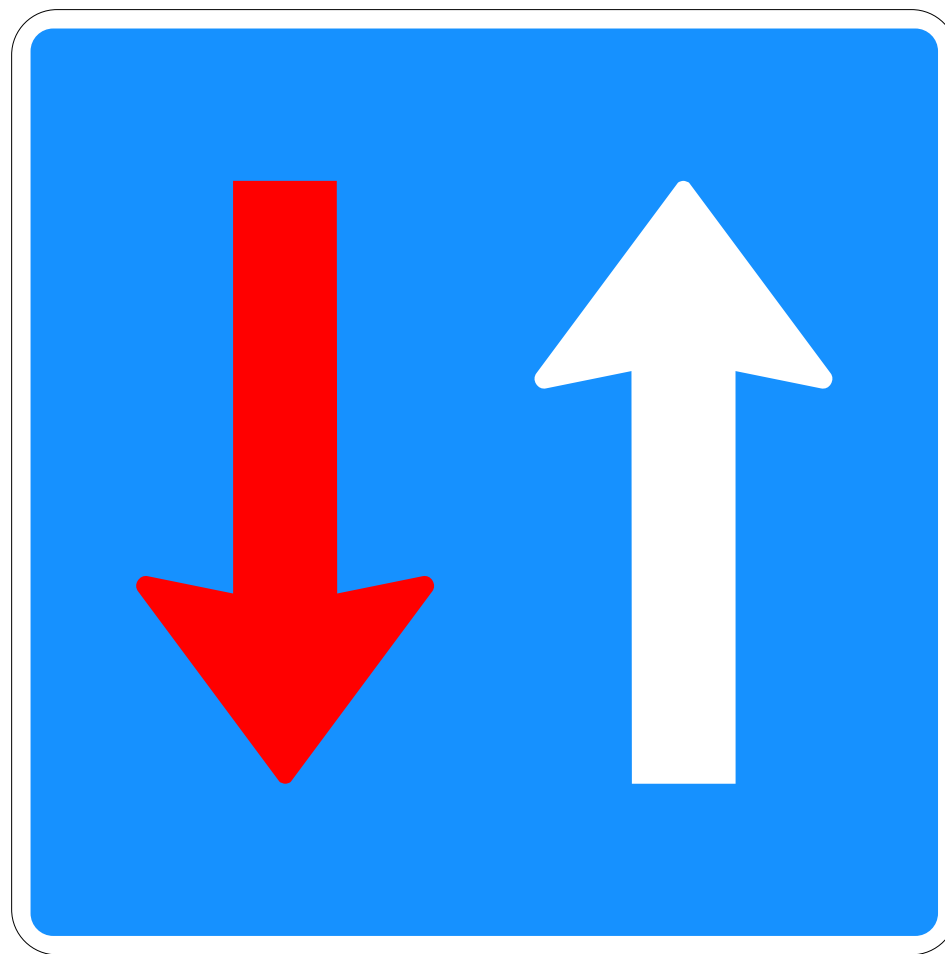

D05.11 Umferð á mót
veitir forgang



D06.11 Útskot

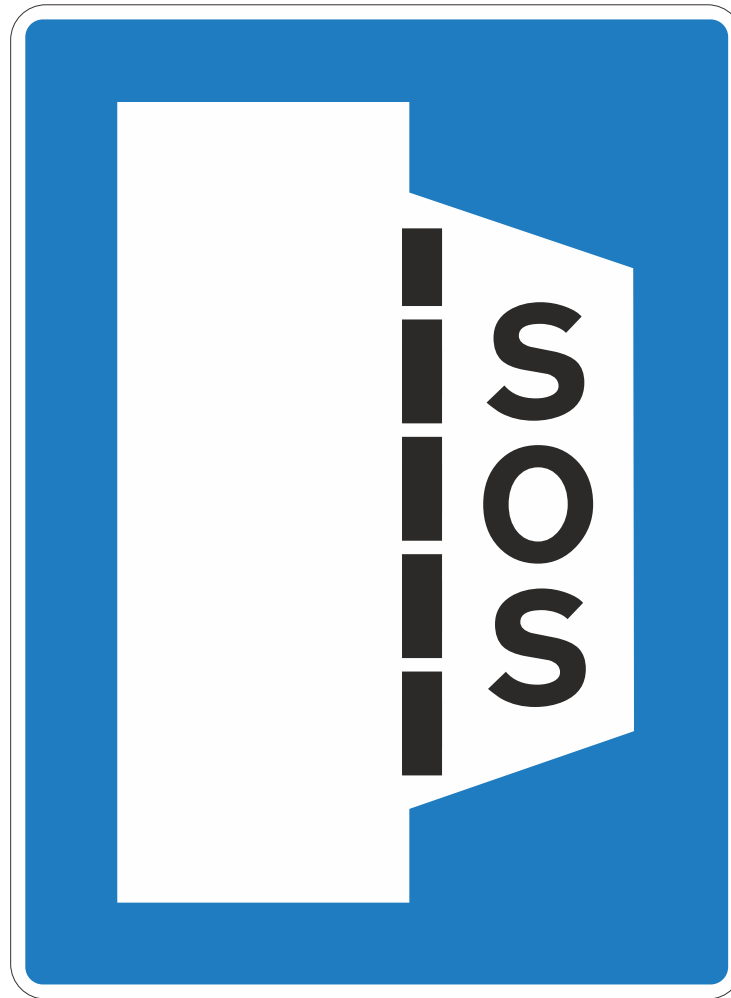

D06.21 Neyðarútskot til hægri



D06.21 Neyðarútskot til vinstri



D06.51 Snúningssvæði til hægri

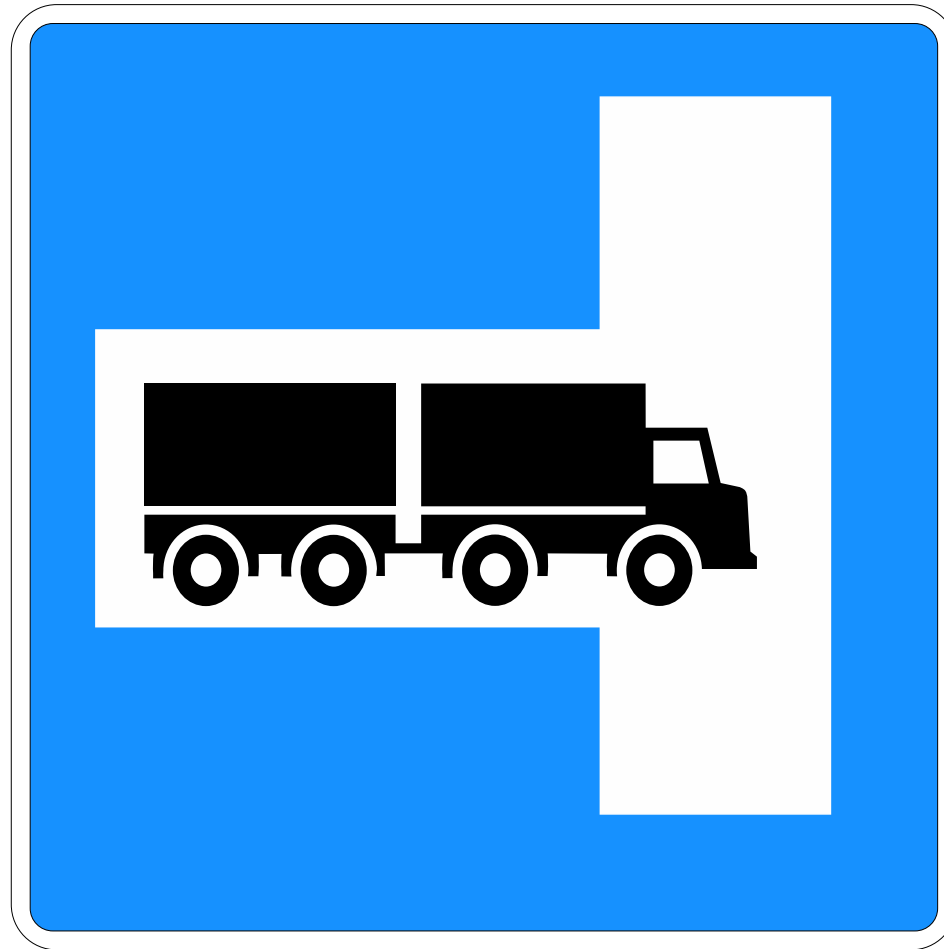

D06.52 Snúningssvæði til vinstri



D07.11 Einstefna

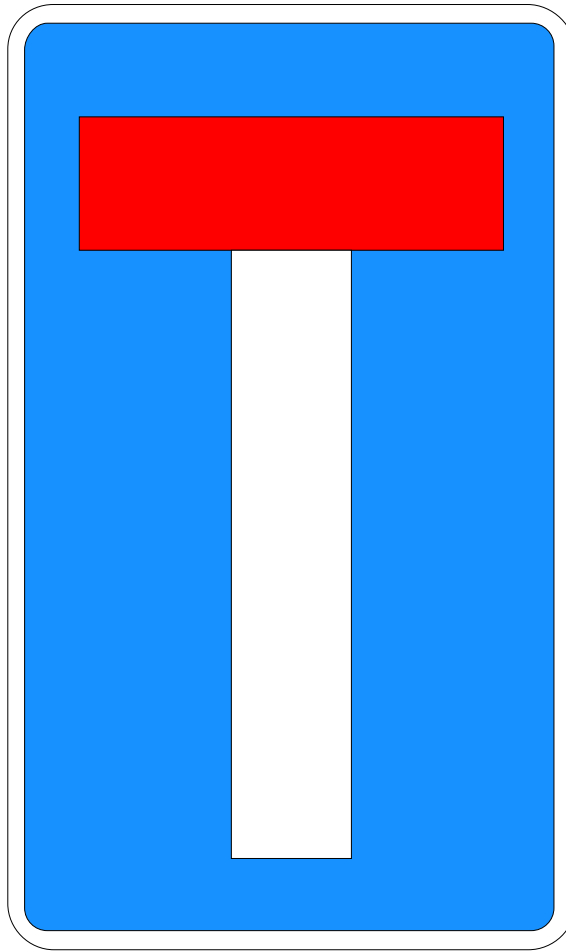

D08.11 Botngata



D09.11 Biðstöð
leigubifreiða

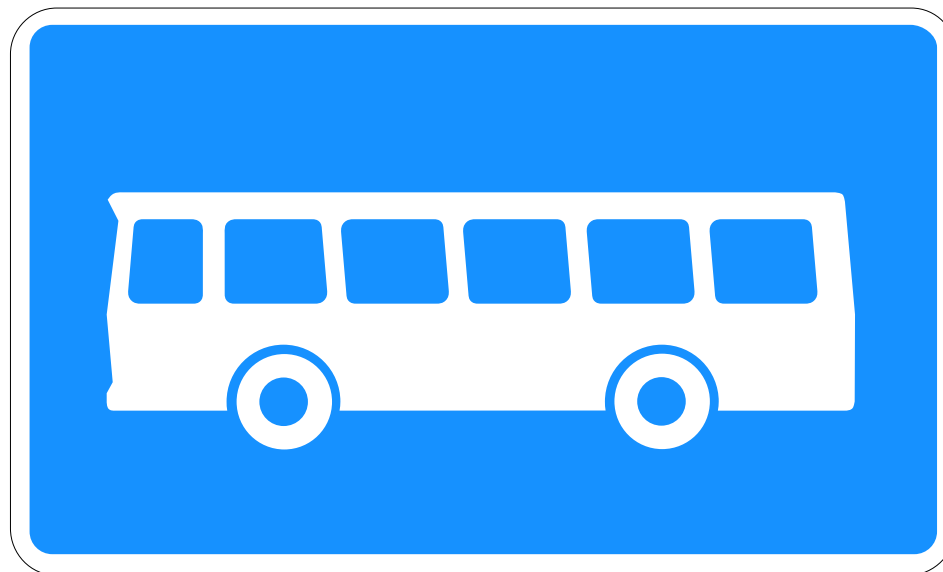

D09.21 Biðstöð strætisvagna
eða áætlunarbifreiða



D09.22 Umferðarmiðstöð



D11.11 Umferð fatlaðra



D12.11 Þéttbýli



D12.21 Pétbýli lokið



D14.11 Vistgata



D14.21 Vistgatu lokið



D16.11 Undirgöng til
hægri



D16.12 Undirgöng til
vinstr



D16.21 Brú til hægri



D16.22 Brú til vinstri



D18.11 Inn



D18.21 Út

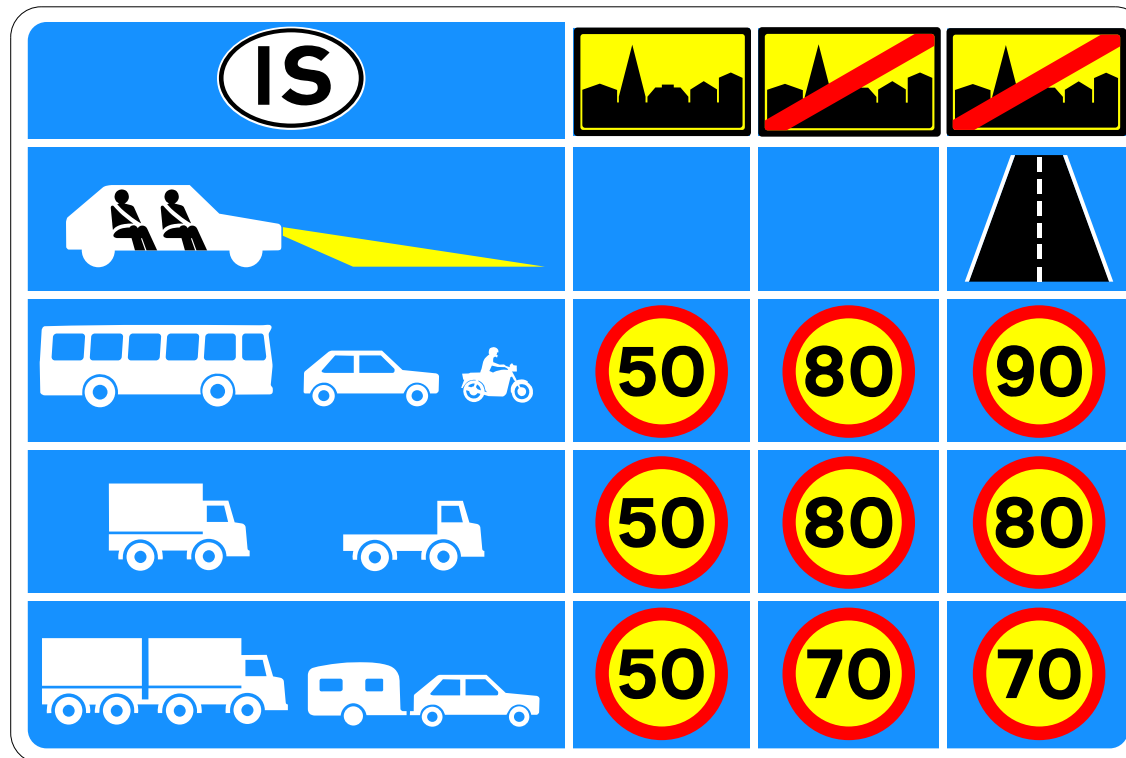

D20.11 Hámarkshraða-
upplýsingar

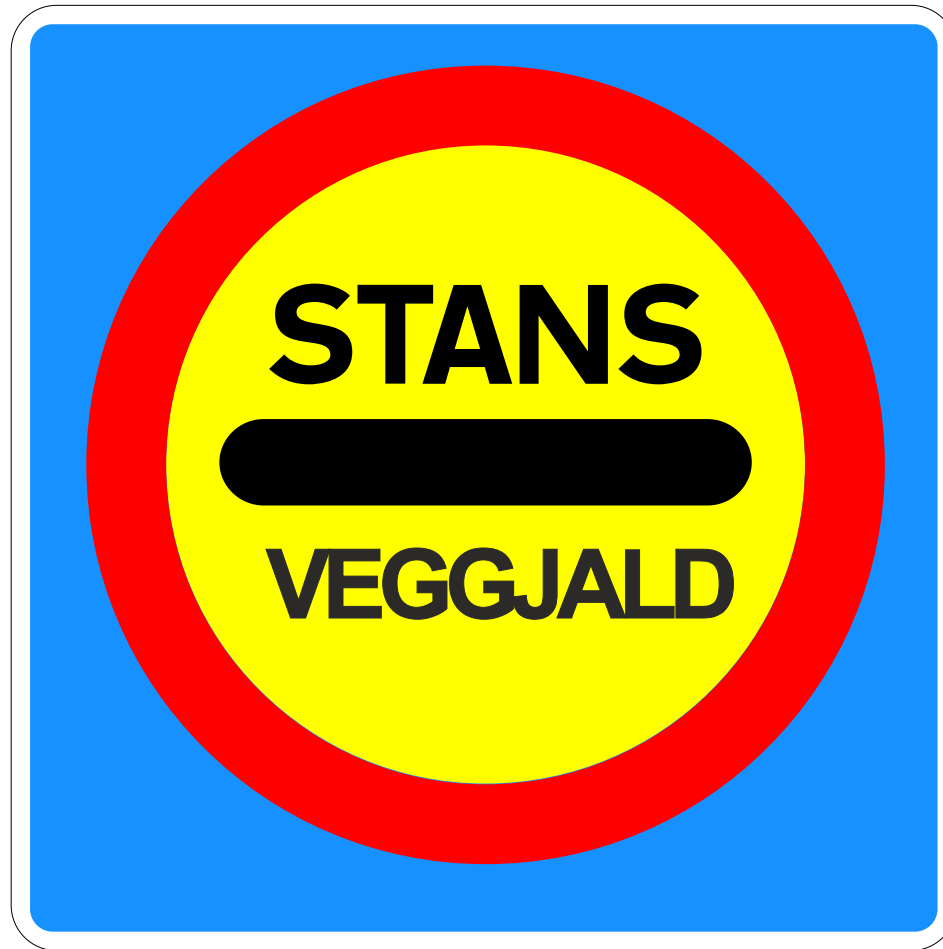

D24.11 Vegur þar sem
krafist er veggjalds



D28.11 Löggæslumyndavél

D30.11 Vatnsverndarsvæði



Öll mál í mm

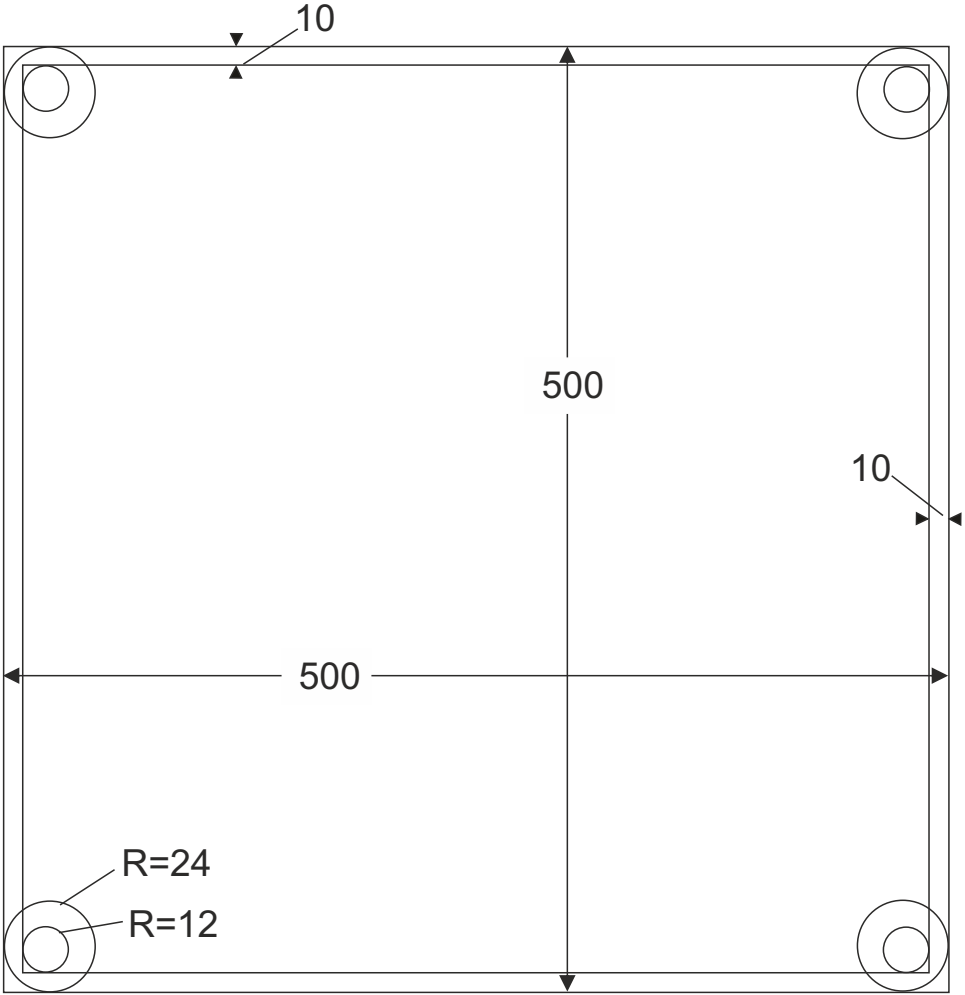

Öll mál í mm

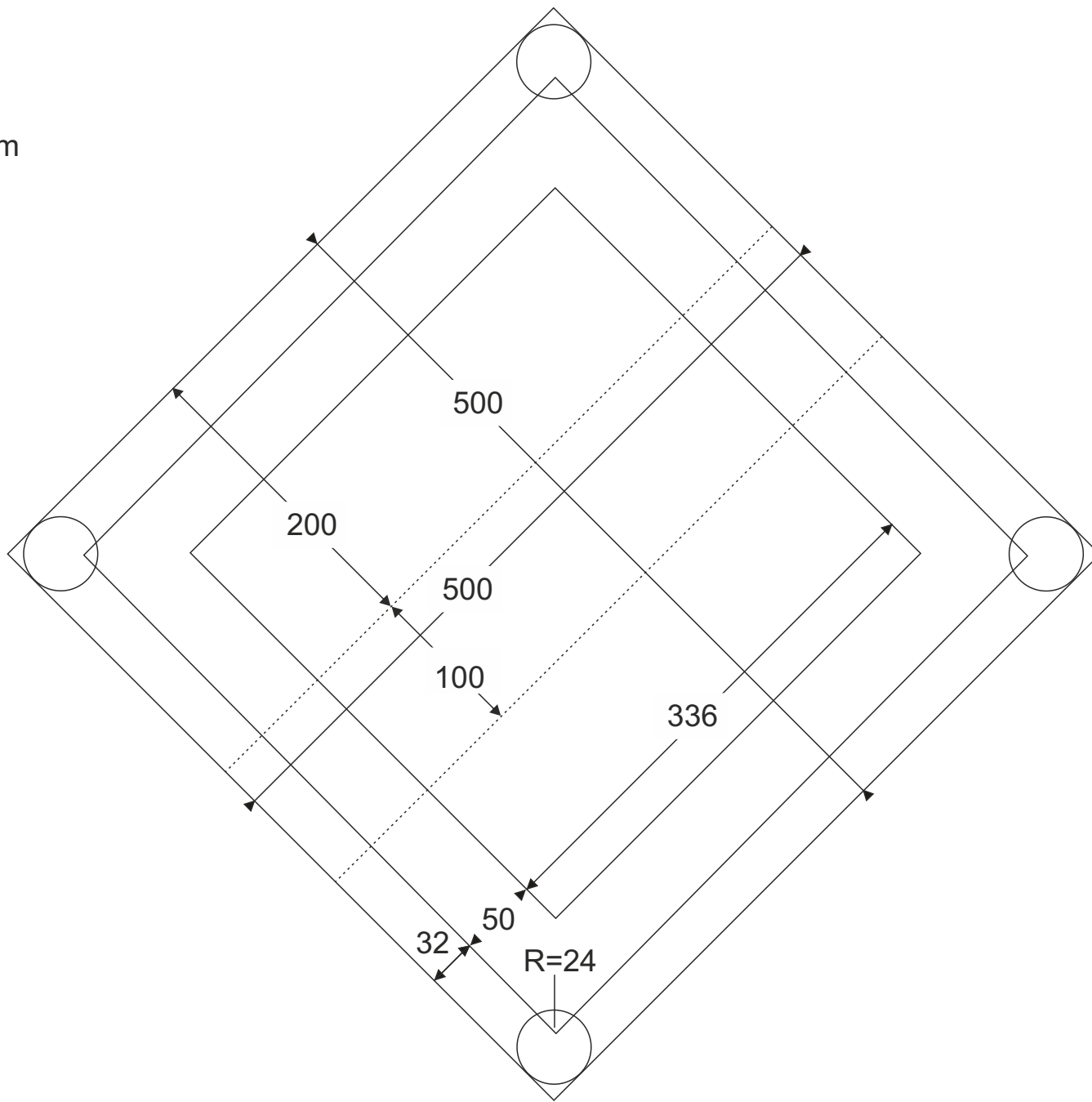

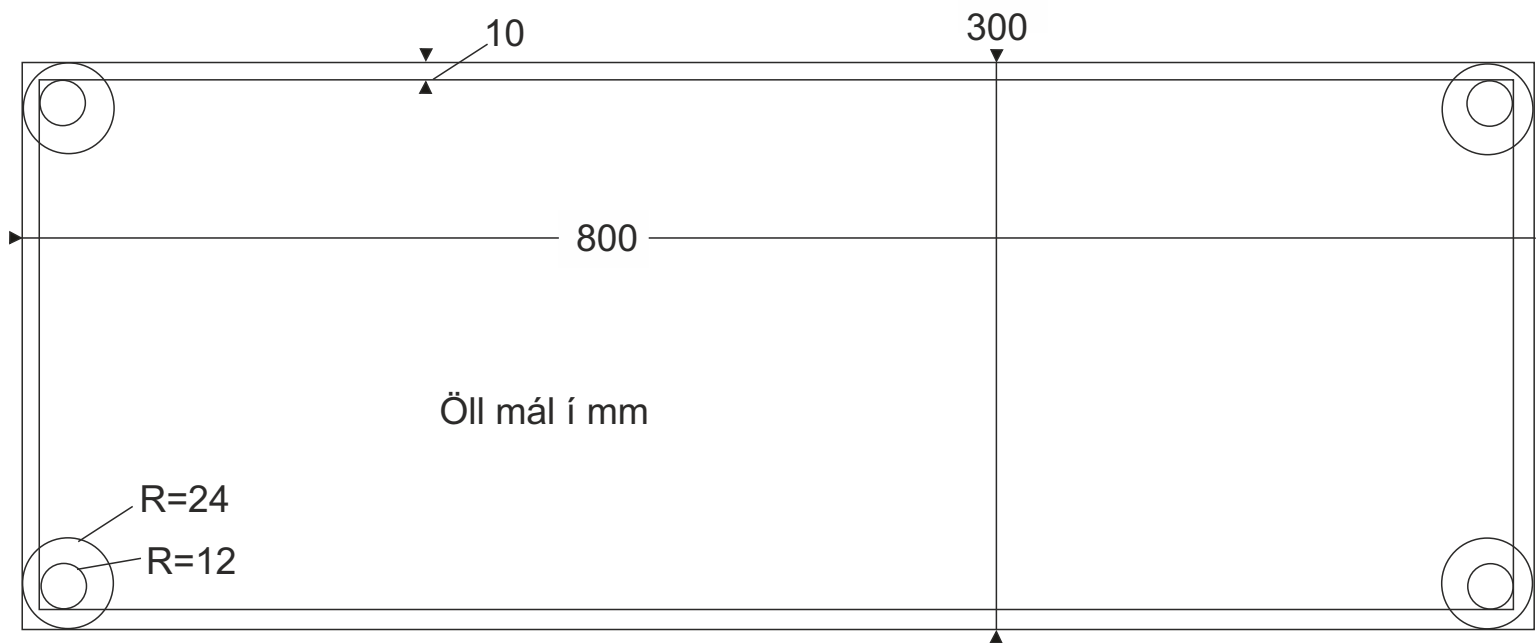

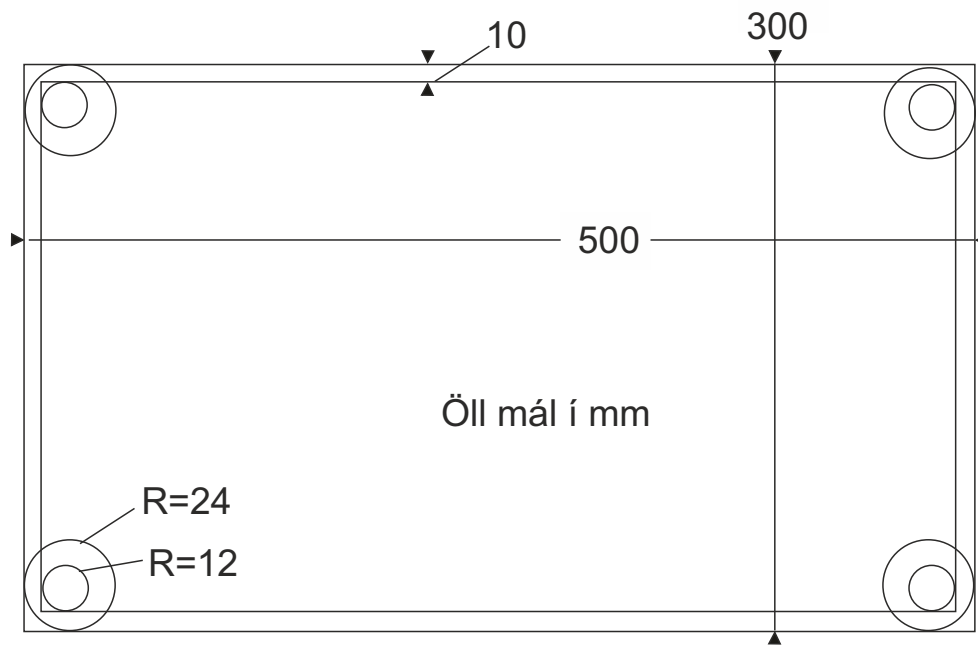

(1/8)

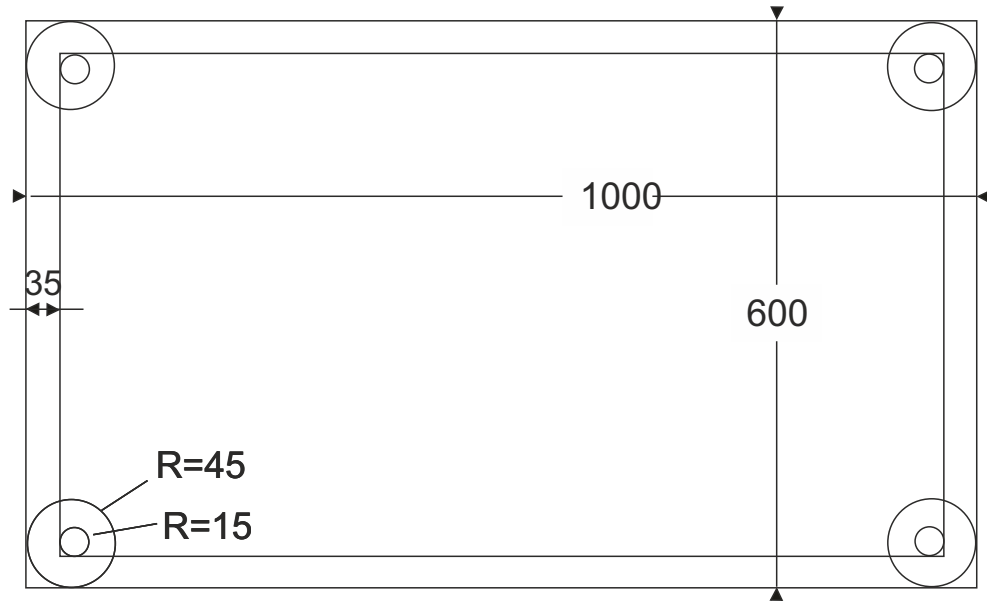

Öll mál í mm

